

knitter-switch



Input Systems

knitter-switch Overview

knitter-switch is one of Europe's leading manufacturers of switches. Since its foundation in 1966, **knitter-switch** has remained at the forefront of switch technology and now provides an unrivalled range of switching solutions from basic toggle types to tact switches and membrane and rubber keypads for today's most complex and demanding control applications.



knitter-switch continues to design new switching solutions, employing the latest technologies and materials while ensuring compliance to continuously evolving legislation. We offer the most complete range of switches available to design engineers and bring the added benefits of a local design service, fast turn around on quotations and production quality prototypes together with Far East pricing.

knitter-switch has its headquarters near Munich, Germany and has subsidiary companies in the UK, France and Asia and strategic alliances with a number of leading global distributors.

Membrane Keypads, Rubber Keypads and complete units with Touch Screens

Membrane keypads offer a unique combination of features to enable fast and simple supply of customer-specific keypads. High quality products, designed in Germany and manufactured in Asia to ensure competitive prices, are backed up by local design and sales support to ensure fast and accurate communications and rapid delivery of each customer's requirements.

Switches are available in flat, poly-domed and metal-domed types, giving a variety of levels of tactile feedback, and life expectancy in excess upto one million operations. All **knitter-switch** membrane keypad designs are tested for resistance to surface scratching, thermal shock, electrical ratings and operating lifetime.

Silicone rubber keypads are manufactured from elastic, non-toxic silicone rubber compounds. Silicone keypads are processed from compression or injection molding. The result is an economic and reliable keypad for small, medium and large production runs. Silicone keypads can be integrated with printed circuit boards or flexible circuits and have excellent resistance to temperature and aging.

Touch screens are available with resistive or capacitive principles as complete customized functional units integrated in modules such as front panels.

Input Systems

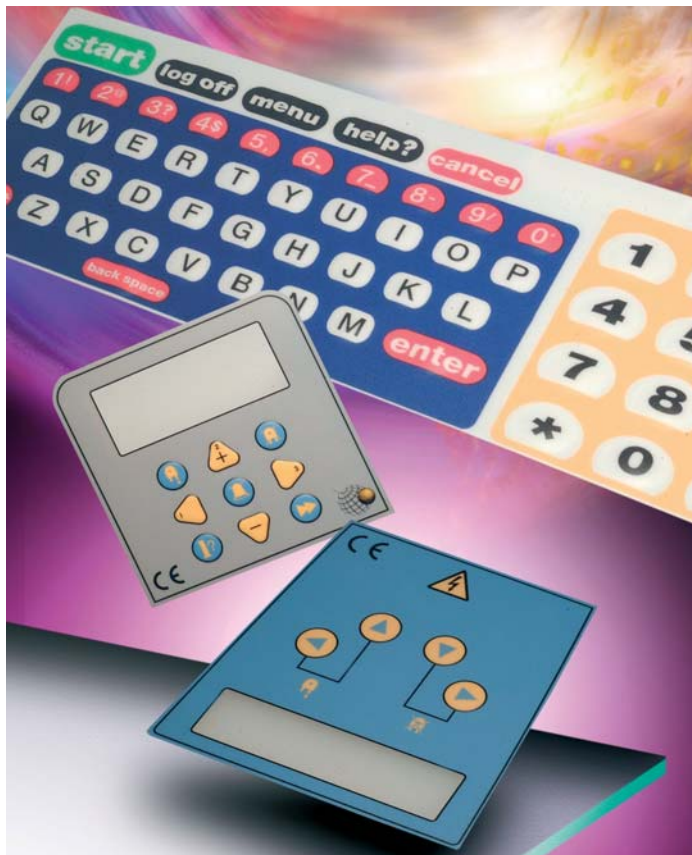

Membrane Keypads

- Graphic overlay only or full switching membrane
- Metal, polydome or pushgate contacts
- Tactile or non-tactile feel
- Integrated touch screens, encoder, LEDs and other components
- LCD windows
- ESD/RFI shielding
- Insertable legend options



Rubber Keypads

- Backlighting options
- Various coatings eg epoxy, polyurethane
- Harder rubber options to give 'plastic' feel
- Various travel/operating force options
- Combination with tactile switches
- Wide variation of colours and designs
- Plastic key tops available



Rubber Keypad Design

Basic Construction Illustration

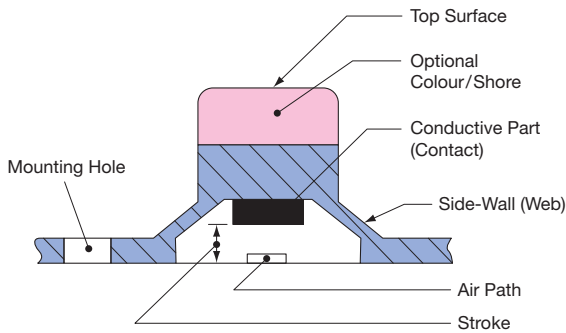

Life Test

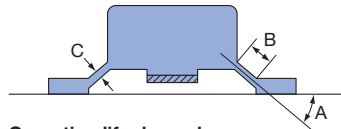

Operating life depends on:

- **Soft Material** ... 50 Shore is preferred.
- **Low Stroke** ... less than 1 mm.
- **Angle** (as part A illustrated above) ... 40-degree is recommended.
- **Length of side-wall** (as part B illustrated above)
- **Thickness of side-wall** (as part C illustrated above) ... determined by key structure. The thicker the web, the higher the operating force.

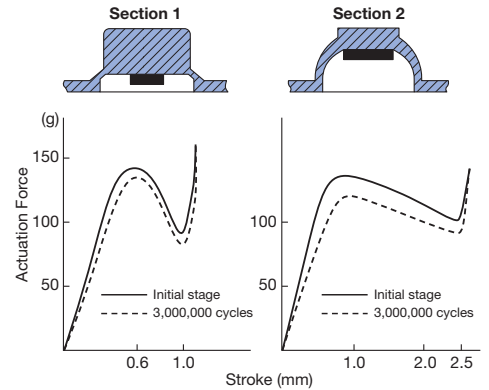

Tolerance Requirement of Silicone Rubber Key

Dimensions:		Actuation Force:	
0 ~ 10 mm	± 0.10 mm	50 ~ 60 grams	± 15 grams
10 ~ 20 mm	± 0.15 mm	61 ~ 80 grams	± 20 grams
20 ~ 30 mm	± 0.20 mm	81 ~ 100 grams	± 25 grams
30 ~ 40 mm	± 0.25 mm	101 ~ 120 grams	± 30 grams
40 ~ 50 mm	± 0.30 mm	121 ~ 150 grams	± 35 grams
50 ~ 60 mm	± 0.35 mm	151 ~ 200 grams	± 40 grams
60 and above	± 0.6%	201 and above	± 25%

Force-Stroke Curve of Rubber Keypad

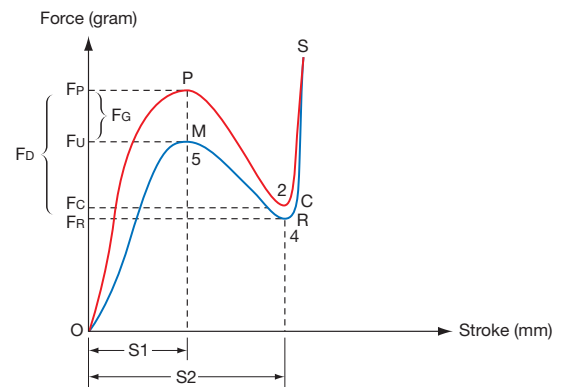

Force	
FP	Peak Force (FMAX)
FU	Max. Return Force
FC	Contact Force
FR	Min. Return Force (FMIN)
FM	Max. Return Force
FD	Drop Force (FD = FP - FC)
FG	Gap Force (FG = FP - FM)

Location	
O	Original Point
P	Peak Point
C	Contact Point
R	Return Point
M	Max. Return Point

Stroke	
S1	Peak Stroke
S2	Contact Stroke

Travel	
O-P	Peak Force (FMAX)
P-C	Contact Force
C-S	Min. Return Force (FMIN)
S-R-M-O	Gap Force (FG = FP - FM)

Depending on the size of contacts and keyboard layout.

Typical Key Sections and Characteristics

		<p>Force Range 30 ~ 350 grams</p> <p>Stroke Range 0.5 ~ 3.0 mm</p> <p>Cycle Life (x10³) 500 ~ 2000</p> <p>Typical uses Telephone, Remote Control, Automotive, Radio, Toys, Calculator, etc.</p>
		<p>Force Range 30 ~ 250 grams</p> <p>Stroke Range 0.7 ~ 2.5 mm</p> <p>Cycle Life (x10³) 500 ~ 2000</p> <p>Typical uses Telephone, Remote Control, Toys, Games, Calculator, etc.</p>
		<p>Force Range 30 ~ 150 grams</p> <p>Stroke Range 0.5 ~ 3.0 mm</p> <p>Cycle Life (x10³) 1000 ~ 3000</p> <p>Typical uses Telephone, Remote Control, Toys, Measuring Instruments, Office Machine</p>

		<p>Force Range 30 ~ 80 grams</p> <p>Stroke Range 2.0 ~ 4.0 mm</p> <p>Cycle Life (x10³) 5000 ~ 20000</p> <p>Typical uses Computer, Typewriter etc.</p>
		<p>Force Range 30 ~ 200 grams</p> <p>Stroke Range 1.0 ~ 2.5 mm</p> <p>Cycle Life (x10³) 500 ~ 3000</p> <p>Typical uses Telephone, Typewriter, Test Instruments, etc.</p>
		<p>Force Range 20 ~ 80 grams</p> <p>Stroke Range 0.2 ~ 1.0 mm</p> <p>Cycle Life (x10³) 500 ~ 10000</p> <p>Typical uses Typewriter, Household Appliances, Computer, etc.</p>

Rubber Keypad Design

Some Special Design Illustrations

1. Different shorehardnesses in the basic keypad and key

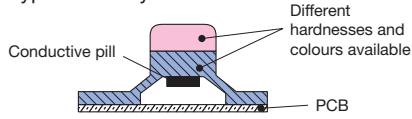

2. Push or pull thru to anchor keypad to PCB

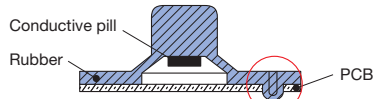

3. Back lighting – option 1

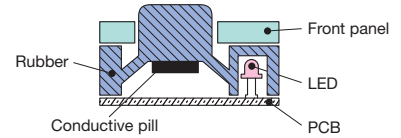

4. Squared key top design with LED light pipe

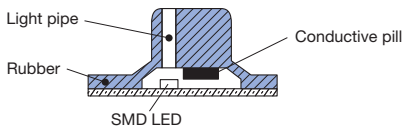

5. Back lighting – option 2

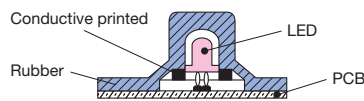

6. Control of travel distance

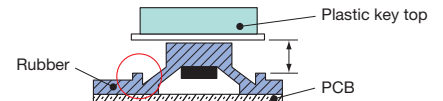

Special Design for Construction Ideas

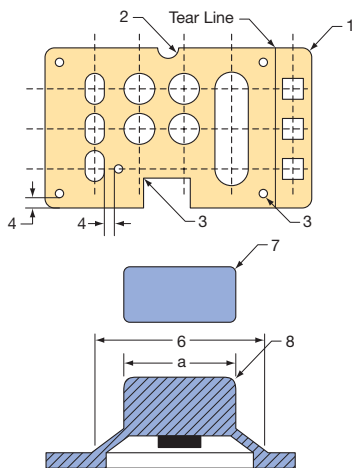

1. Typical outside radius is 1.0 to 1.5 mm.
2. Minimum radius is 0.3 mm.
3. Minimum inside radius is 0.2 mm.
4. Spacing between the edges of a rubber dome and a guide hole is 1.0 mm or more.
5. Guide holes are min. 1.0 mm in diameter.
6. The width of a rubber dome base is typically 2.0 mm more than a.
7. The minimum radius for the side edges of key top is 0.25 mm.
8. The minimum radius for the top edges of key top is 0.2 mm.

Guideline for Assembly Design

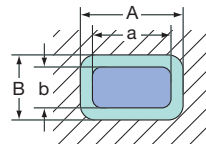

A & B : dimensions of plastic
a & b : dimension rubber
A-a ≥ 0.5 mm, B-b > 0.5 mm

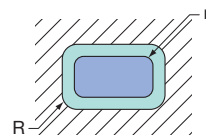

R : the corner radius of plastic
r : the corner radius of rubber
1mm ≤ R ≤ 1.25 mm, 0.75 mm ≤ r ≤ 1 mm is better

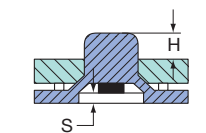

H : the dimension of key tops & plastic
S : the stroke of key pad
H-S ≥ 1.5 mm

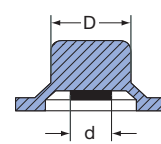

D-d = 1.5 ~ 2.0 mm

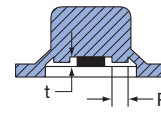

P : diameter of post
t : the gap between post & conductive pill
P = 1.0 mm is better
t = 0.1-0.15 mm is better

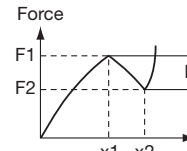

Fc : click force
Fc : F1-F2 > 25 g is better

Guideline for Printing Artwork Design

Button Graphics

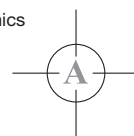

Graphics Off Centre ± 0.3mm

Full Surface Printing

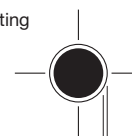

± 0.5mm
0.5mm

Patterns of Conductive Designs

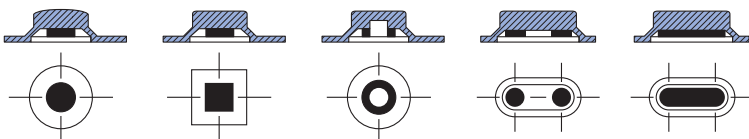

Items	Standard Sizes of Conductive Pill	Conductive Pill Resistance	Less than 150 ohms, with 125 grams loading
Circle	Ø1.5, Ø2, Ø2.5, Ø3, Ø3.5, Ø4, Ø4.5, Ø5, Ø6, Ø7, Ø8, Ø9, Ø10	Life	10 million (min.)
Square/ Ellipse	Recommended size of conductive ink printing contact is flexible.	Print Type Resistance	Less than 500 ohms, with 125 grams loading
		Life	1 x 10 ⁶ max.

Colour / Printing

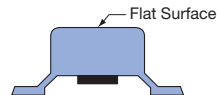
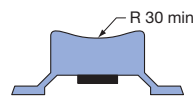
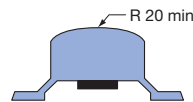

Suitable Key Surface for Legend Printing:

The commonly used colour for the underlay is medium-grey. Customers should provide us with the Pantone code or a colour specimen for both the key button and the legend.

Membrane Keypad Structure

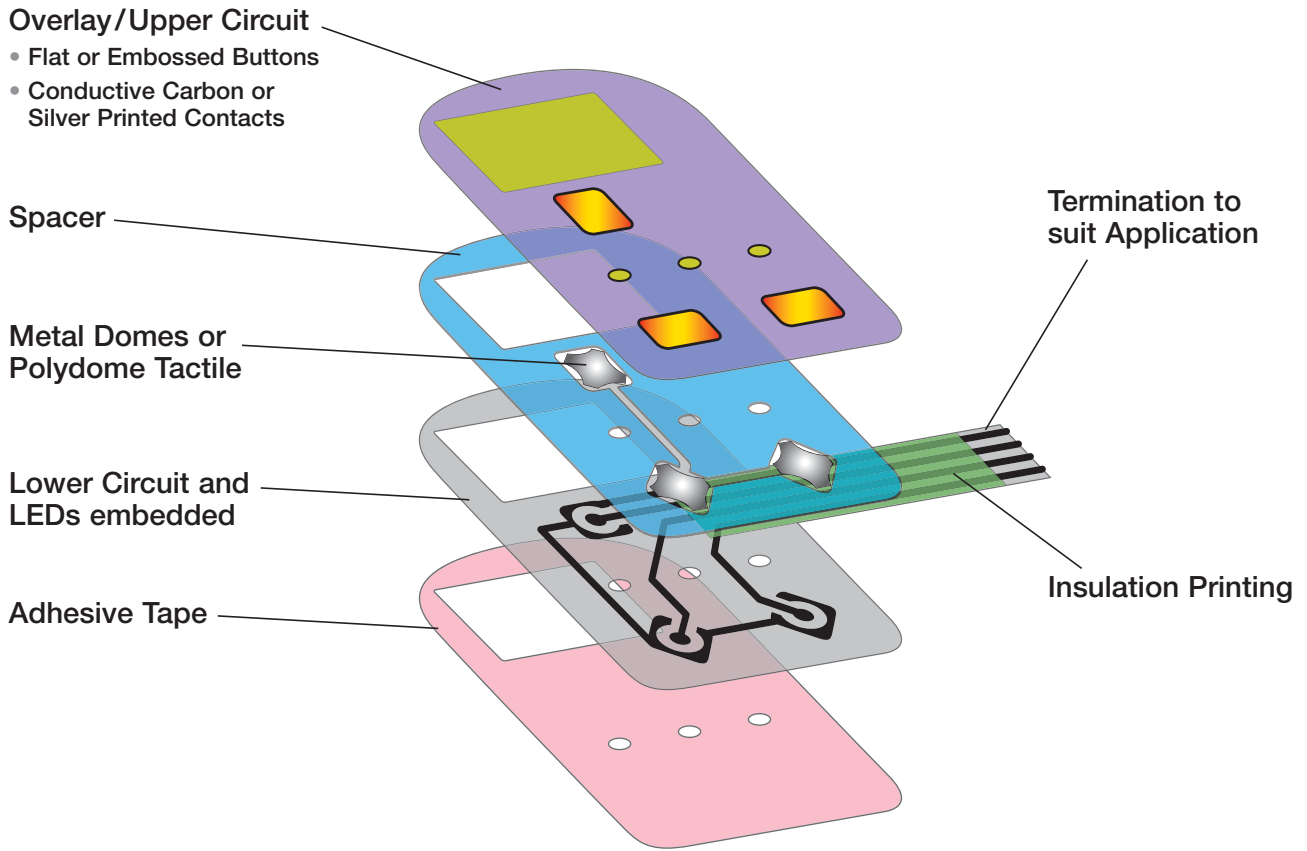

PushGate

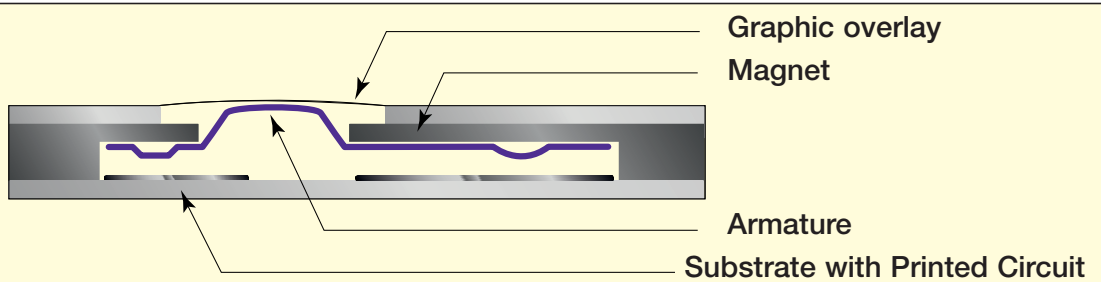

Flat Type (POLYDOME, Non-Tactile)

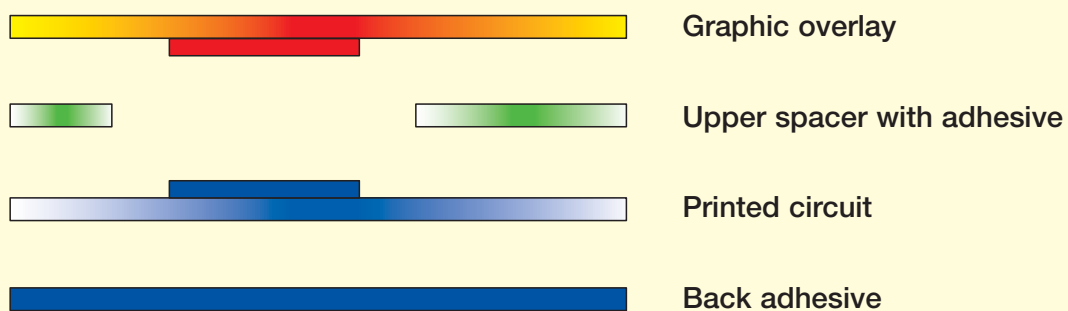

Membrane Switch Structure

Tactile Type

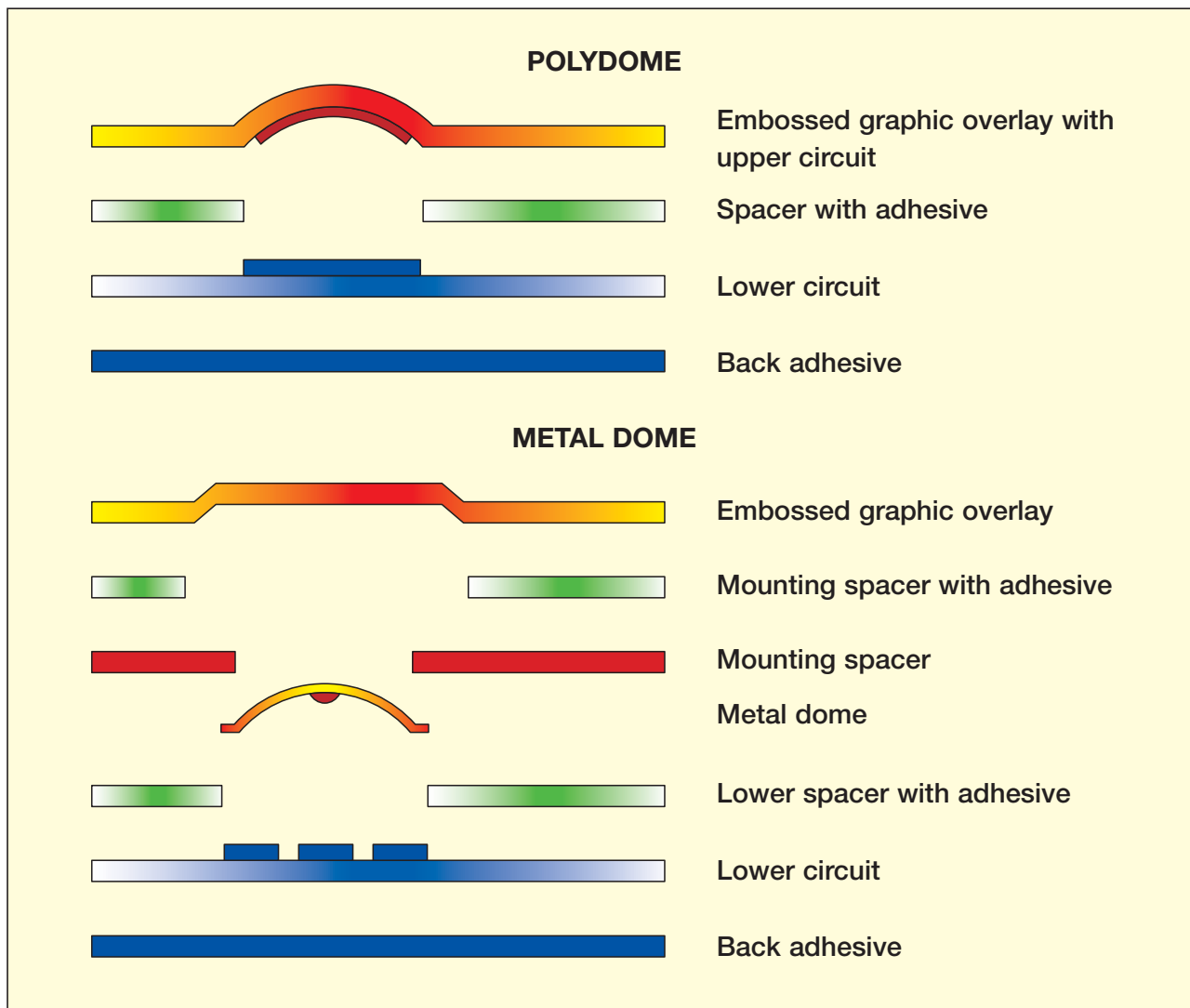

Typical Specification	POLYDOME	METAL DOME	PushGate
Operating voltage	min. 100 mV AC/DC max. 25 VAC / 42 VDC	min. 100 mV AC/DC max. 25 VAC / 42 VDC	min. 3 V AC/DC max. 50 V AC/DC
Breaking current	100 mA	100 mA	50 mA
Max. initial contact resistance	500 Ω	500 Ω	2 Ω
Min. isolation resistance	100 MΩ	100 MΩ	45 MΩ
Operating temperature	-5 °C...+50 °C	-10 °C...+80 °C	-40 °C...+85 °C
Endurance	500 000 operations	200 000 operations	1 000 000 operations
Actuation force	0.3 N...5 N	0.3 N...5 N	2.2 N, 2.8 N
Typ. Travel	0.3 mm...0.6 mm	0.25 mm...0.4 mm	0.3 mm
Typ. Bounce	3 ms	5 ms	1 ms

Capacitive keypads

Capacitive keypads are wear-free input systems with no moving parts, which are operated by touch (sensor) without pressure.

An inexpensive alternative to the touch screen, they consist of an actual keypad with sensor surfaces arranged in fixed positions and a controller IC.

Spatially, the controller can be both assigned to the keyboard or located on the PCB at the equipment end.

The design in terms of shape and colour scheme is essentially restricted only by the type of surface material

used (insulators such as glass, plastic, wood etc.), so it is also easy to produce multidimensionally curved shapes.

Appropriate arrangement of the sensor surfaces makes it possible for keys, sliders, rotary potentiometers etc. to be reproduced easily.

In addition to applications where ease of cleaning is important (medical technology, food industry, household appliances), this process is particularly suitable for designer (lifestyle, multimedia, home automation) equipment.

Structure

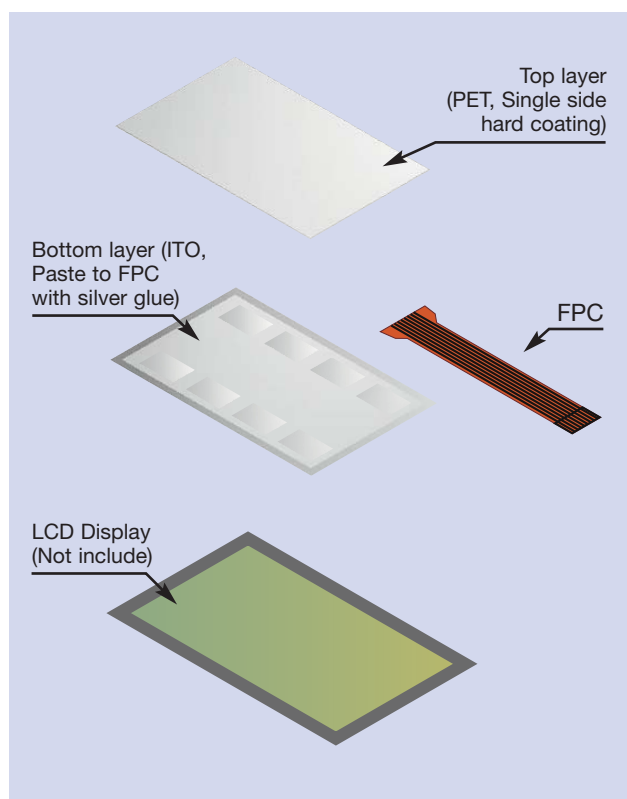

Technical Data for the Controller

Operation voltage	2.7...5.5 V
Power consumption	80 μ A typ.
Inputs/Outputs	8 sensor surfaces / 8x digital (L or H active)
Operating temperature	-20°C ~ +70°C

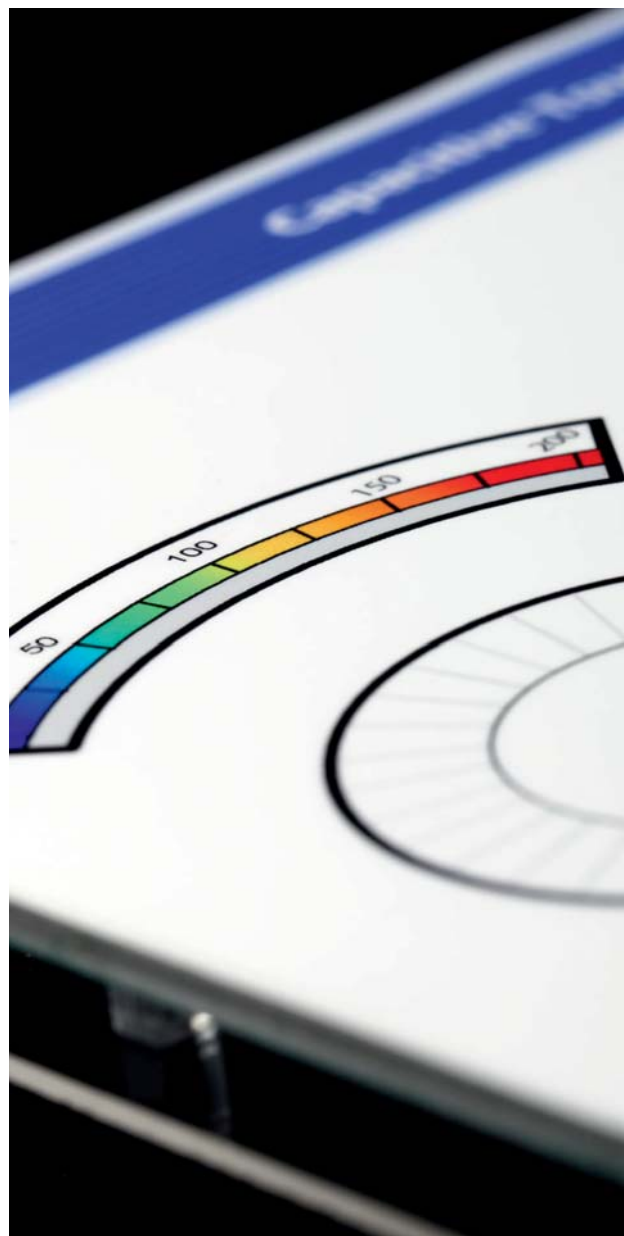

Functional units with touch screens

Touch screens operating according to resistive or capacitive principles are an obvious choice for applications in which, as in a monitor display, a variety of input fields (differing in terms of number, size, arrangement) are designed to be active and a robust, closed surface is required.

knitter-switch supplies complete customized functional units in which touch screens, optionally in combination with film keypads, are integrated in modules such as front panels.

Resistive touch screens

These consist of a carrier layer (glass, film) and a surface layer (film), the facing surfaces of which are coated with a transparent conductive material and are held in position in close proximity to one another.

When the film is pressed onto the carrier at a particular point, a conductive connection is created there, the position of which can be determined by means of voltage measurements along the X and Y axes.

Its simple design with a movable surface layer means that the system is inexpensive, but not wear-free.

Since such input systems can also be used with styluses, prostheses etc, they are the technology of choice where accessibility is important.



Capacitive touch screens

These consist of a transparent substrate which is coated with a conductive layer and has an AC voltage source arranged on each of its four corners. When you touch this with your finger, four different currents are produced, and the position can be calculated from the relationship of these currents to one another.

Specifications (based on the resistive touch screen as an example)

Dimensions	customized
Operation voltage	5 VDC
Insulation resistance	> 20 MΩ
Operating temperature	-20°C ~ +70°C
Service life	>1x10 ⁶ (pen hitting) or >1x10 ⁵ (pen sliding)
Linearity deviation	< 1.5 %
Transparency	> 80 %
Surface hardness	3 H (pencil test)



Layout Inquiry

A large grid for sketching a keypad layout. The grid is composed of 20 columns and 30 rows of small squares, providing a structured area for drawing a keypad design.

Please sketch out your keypad layout and return to us
(See back page for address details)

Keypads Inquiry Form

Company _____

Department _____

Attention _____

Address _____

Postcode _____

Phone _____

Fax _____

Email _____

Web _____

Membrane Requirements

Graphic Layer

Overall size _____

What finish is required (matt, gloss or selective texture) _____

Are windows required _____

Size _____

Position _____

Do they need to be tinted _____

Is embossing required _____

Pillow or rim _____

Number of colours _____

Switches

Number _____

Tactile or non-tactile _____

If tactile: polydome or metal dome _____

Metal means higher unit cost, lower tool cost.

Polydome means lower unit cost, higher tool cost.

Electrical schematic: "x-y-matrix" or "common return"? _____

LEDs

Are embedded LEDs required _____

Number and colour _____

Will a separate tail be required _____

Tail position and length

Position of tail – exit from side and rear _____

Type of connector (if required) _____

If ZIF connector being used, get type for ref. _____

Any special features required

Insert legends _____

Luminescent inks _____

Other _____

Estimated project volume _____

Please complete this questionnaire and return to us with your sketch overleaf

(See back page for address details)

Input Systems

knitter-switch
elektrotechnische erzeugnisse · Knitter & Co. KG

D-85593 Baldham · Postfach 10 02 33 · Neue Poststrasse 17
Tel.: +49 (0) 81 06 / 36 21-0 · Telefax: +49 (0) 81 06 / 36 21 40
E-Mail: info@knitter-switch.com · <http://www.knitter-switch.com>

knitter-switch
S u c c u r s a l e F r a n c e

F-91400 ORSAY · Parc Club Orsay Université · 18 rue Jean Rostand
Téléphone: +33 (0) 1/69 33 11 60 · Télécopie: +33 (0) 1/69 33 11 80
E-Mail: ksfrance@knitter-switch.com · <http://www.knitter-switch.com>

knitter-switch
UK Limited

GB-Basingstoke Hants RG24 8AG · Grove House, Lutyens Close
Chineham Court · Tel: +44 (0) 1256/338670 · Fax: +44 (0) 1256/338671
E-Mail: ksuk@knitter-switch.com · <http://www.knitter-switch.com>

knitter-switch
A S I A L i m i t e d

Office 2 · 19/F, Empress Plaza, 17-19 Chatham
Road South Tsimshatsui · Kowloon · Hong Kong
Tel: +852 23 11 87 99 · Fax: +852 23 11 87 39
E-Mail: ksasia@knitter-switch.com · www.knitter-switch.com

knitter-switch